

PILOT HOUSE SETTEE TABLE/PLAN VIEW  
1'-0"=1'-0"

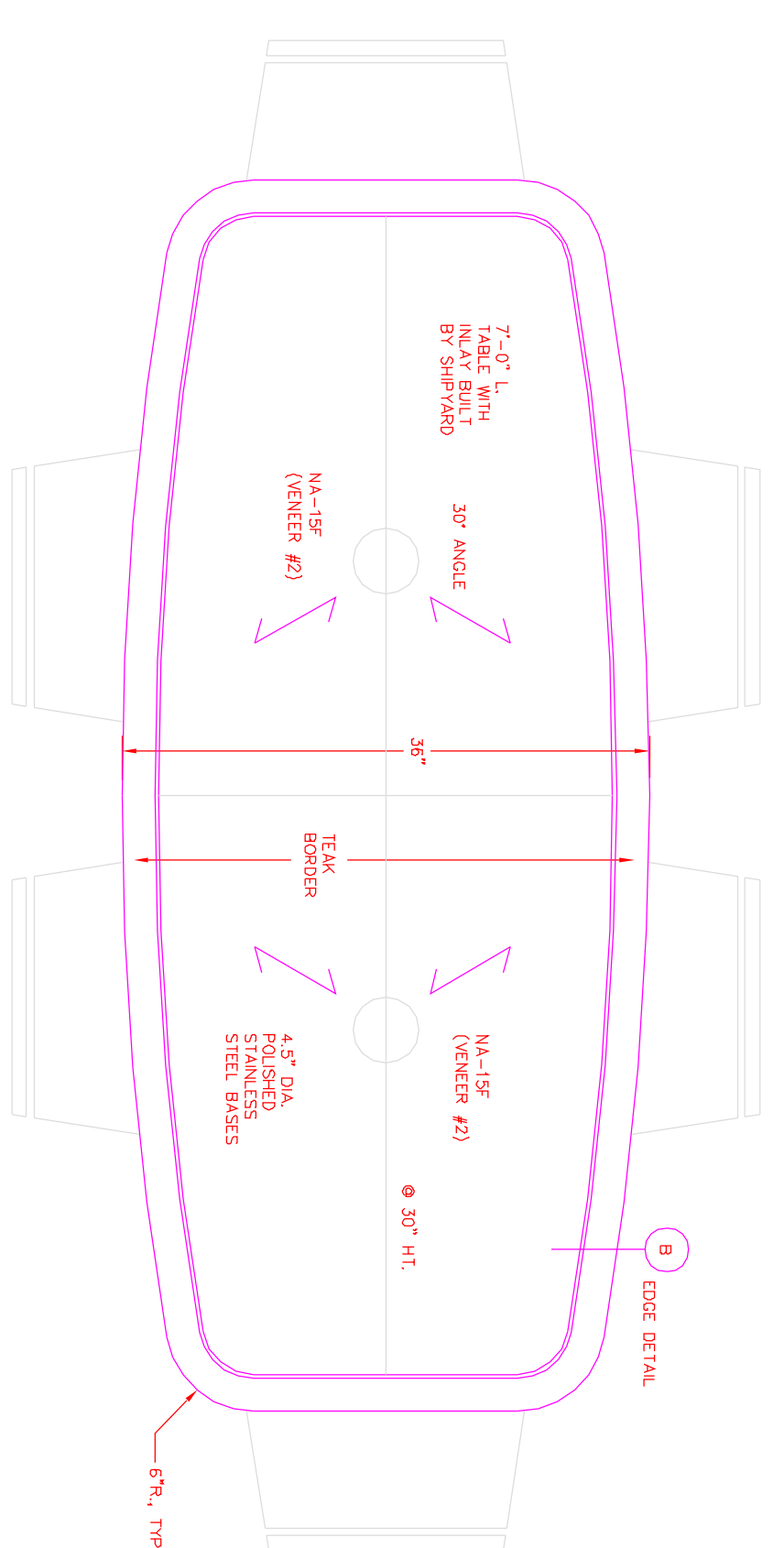

UPPER (PILOT HOUSE) AFT DECK EXTERIOR TABLE/PLAN VIEW  
1'-0"=1'-0"

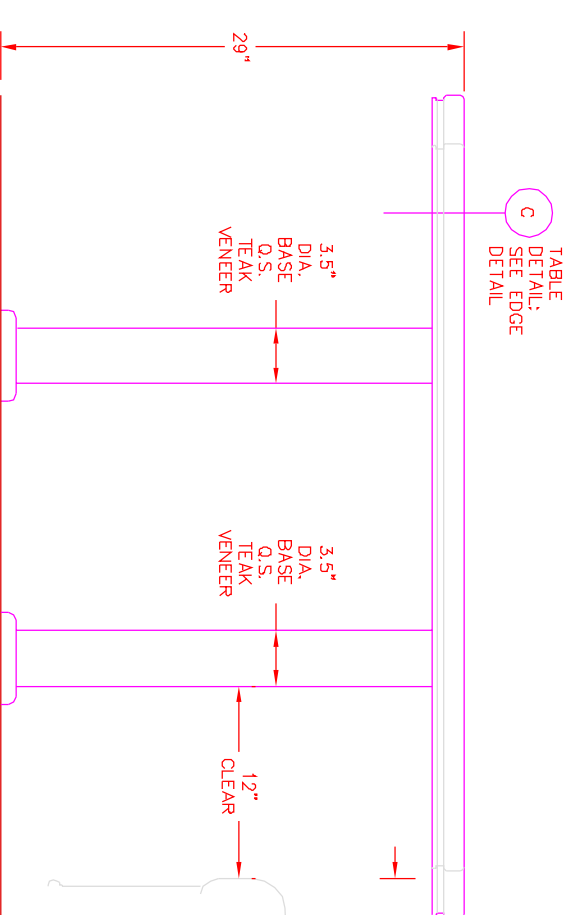

PILOT HOUSE SETTEE TABLE/FRONT VIEW  
1'-0"=1'-0"

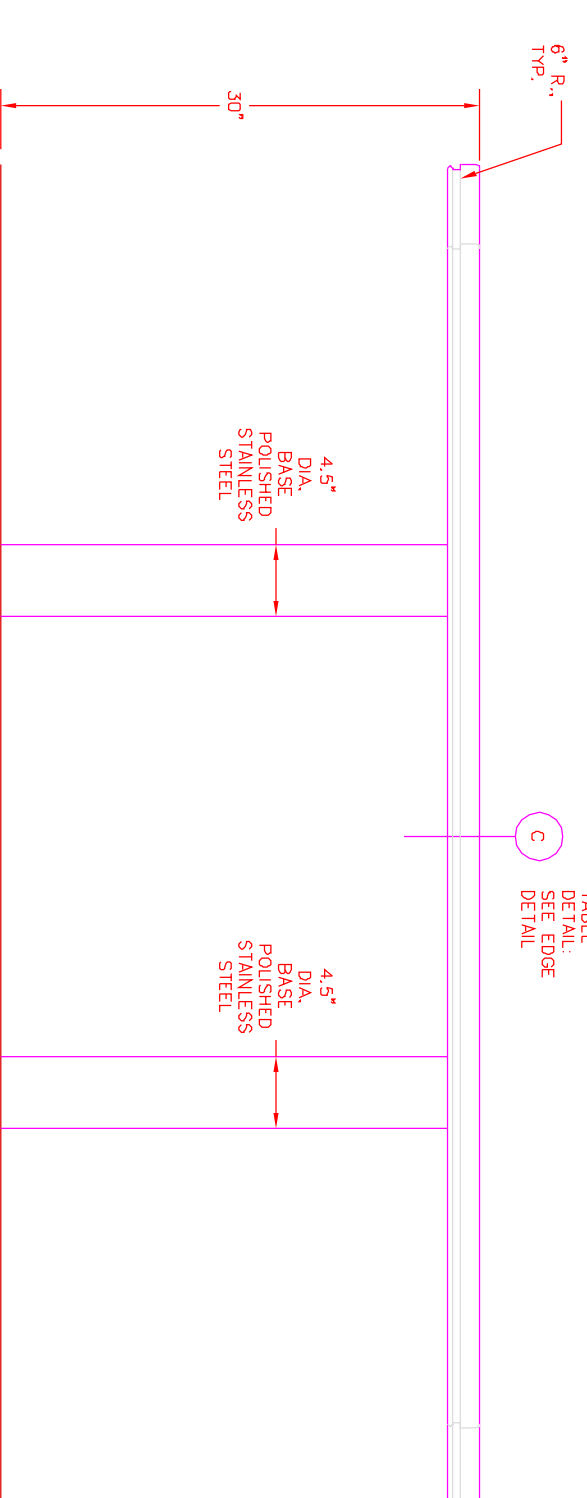

UPPER (PILOT HOUSE) AFT DECK EXTERIOR TABLE/FRONT VIEW  
1'-0"=1'-0"

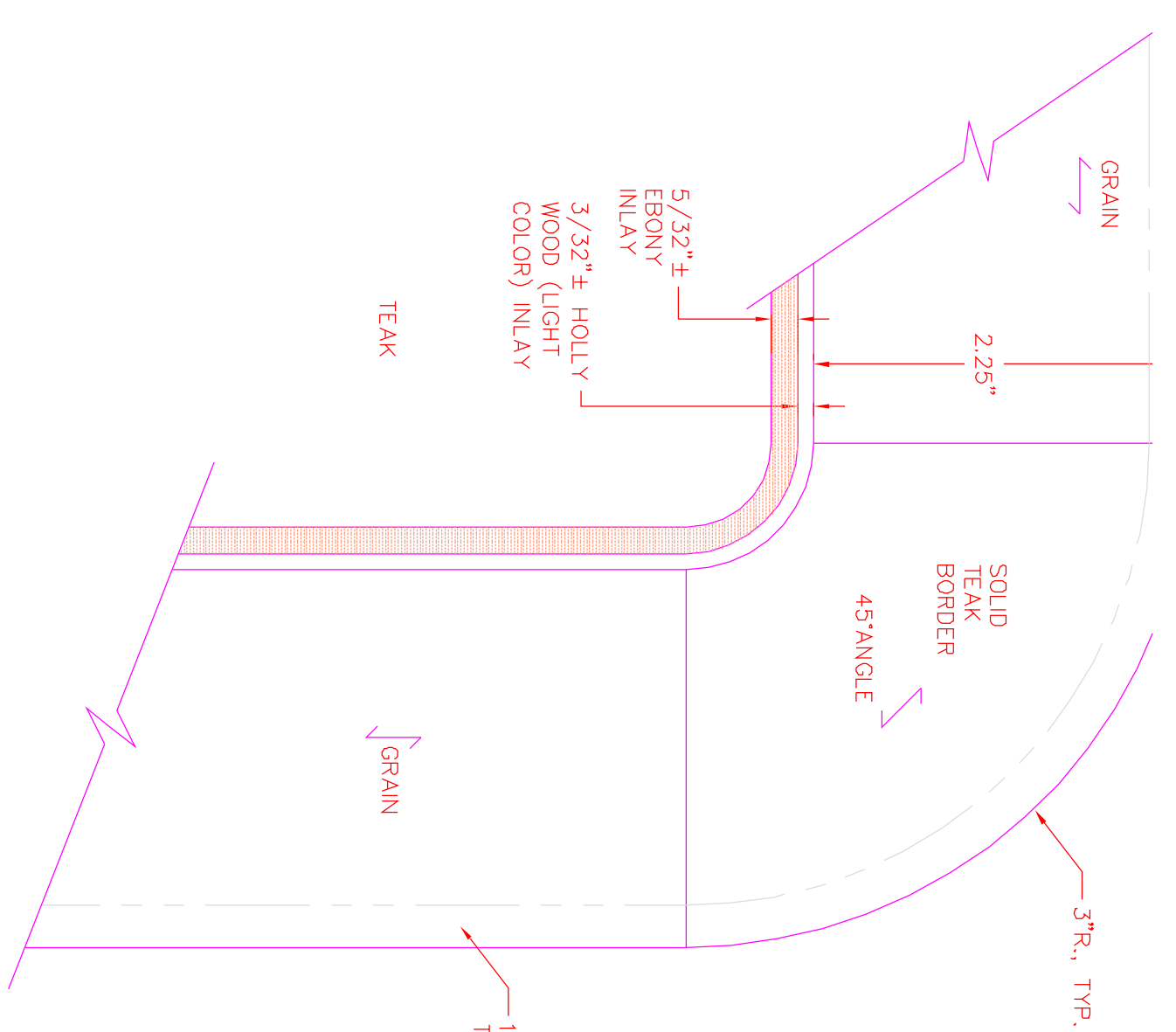

PLAN EDGE DETAIL A  
FULL SCALE

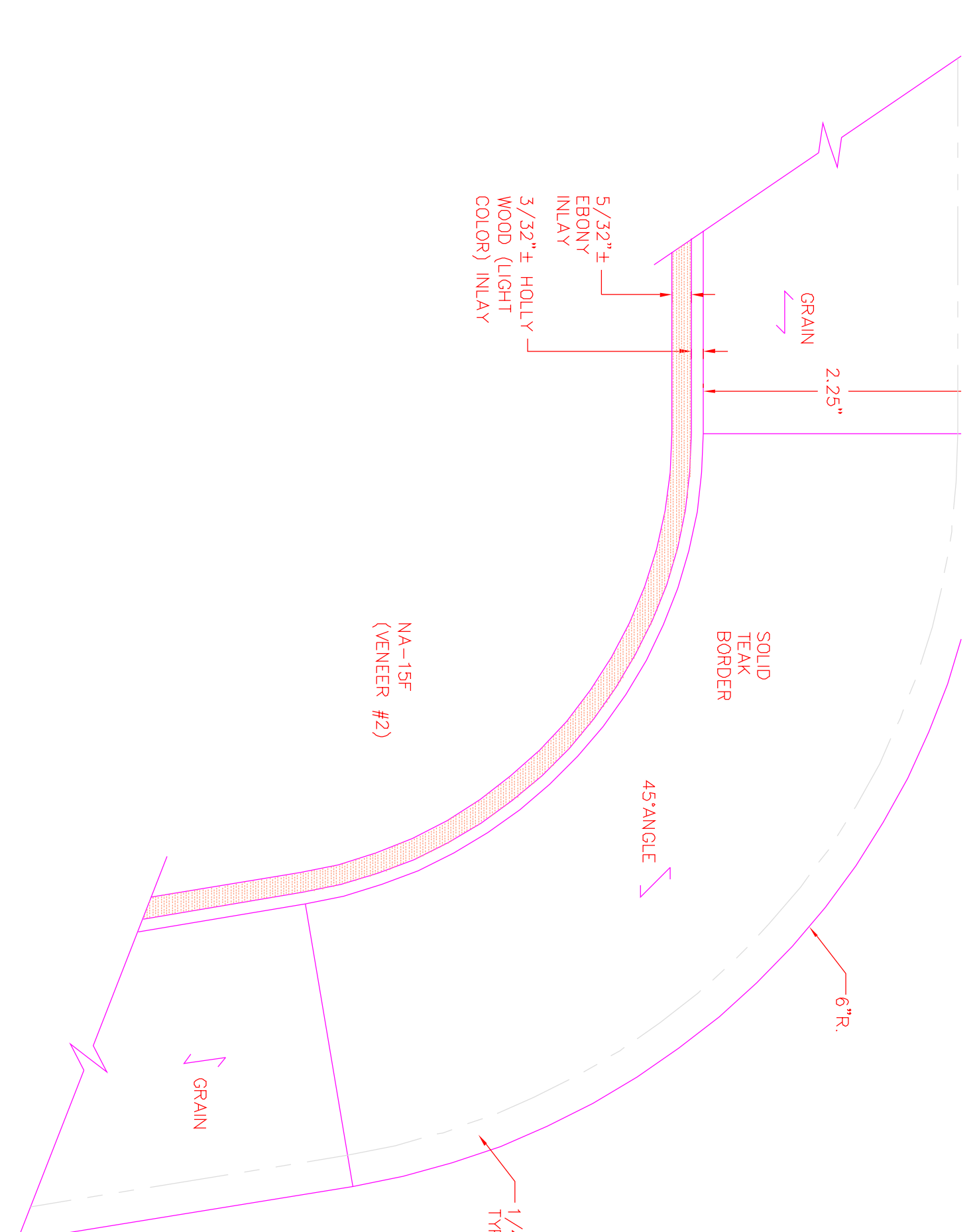

PLAN EDGE DETAIL B  
HALF SCALE

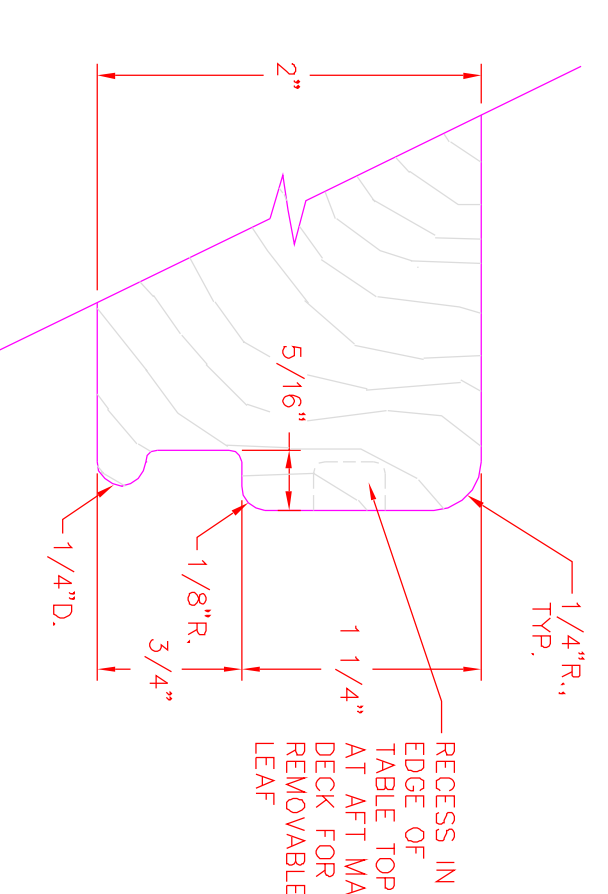

SECTION EDGE DETAIL C  
FULL SCALE

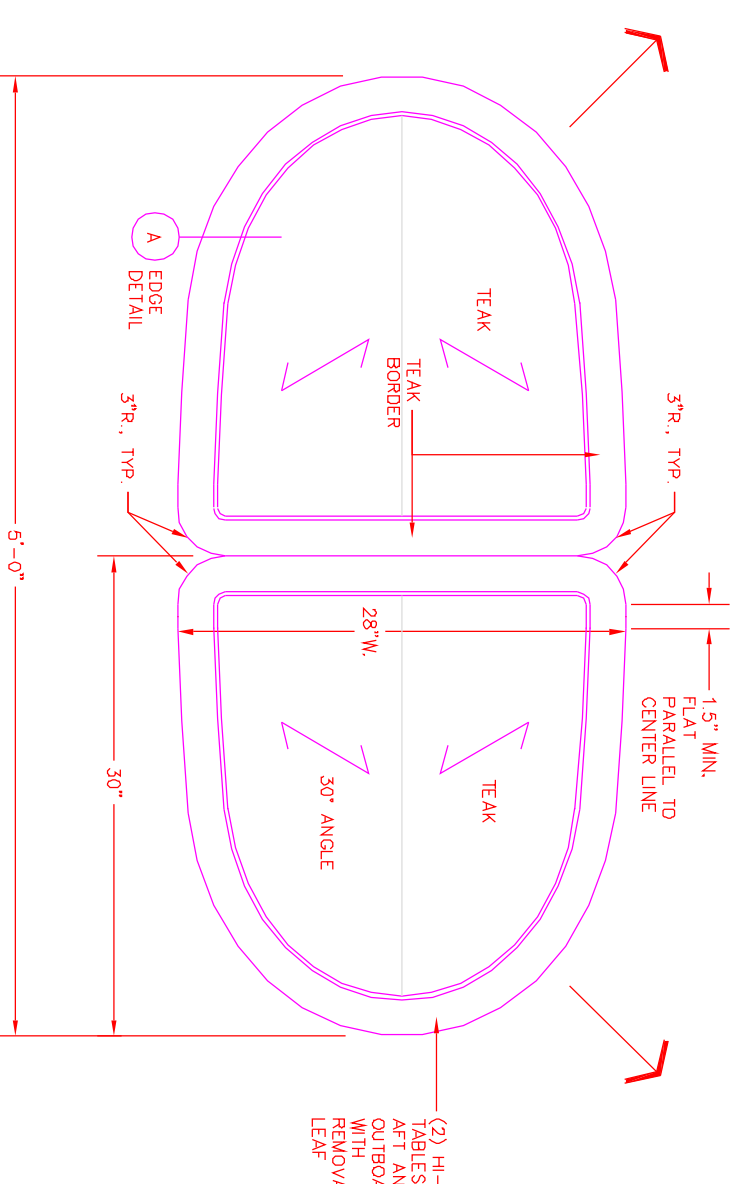

COCKPIT/AFT DECK TABLE/PLAN VIEW  
1'-0"=1'-0"

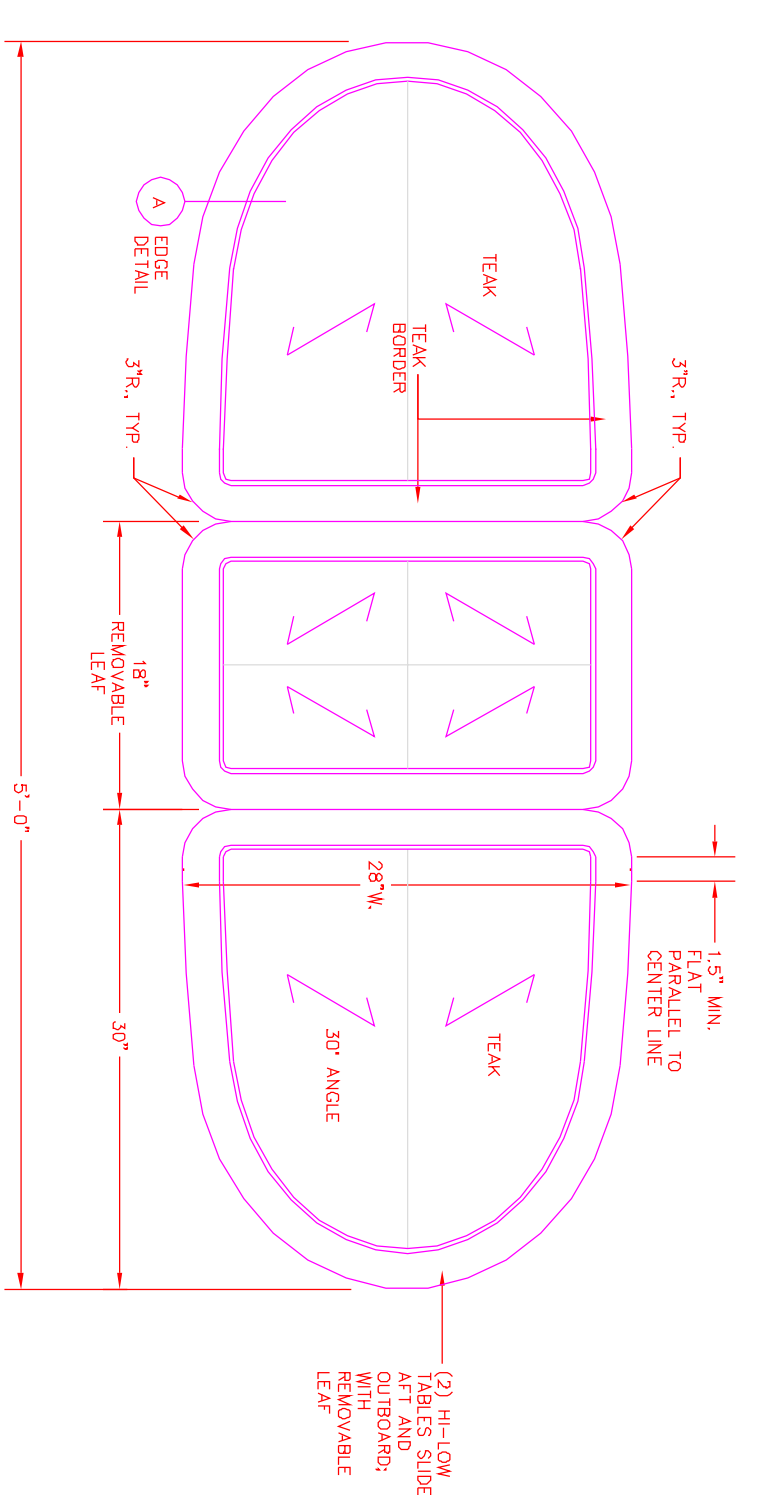

COCKPIT/AFT DECK TABLE/PLAN VIEW  
1'-0"=1'-0"

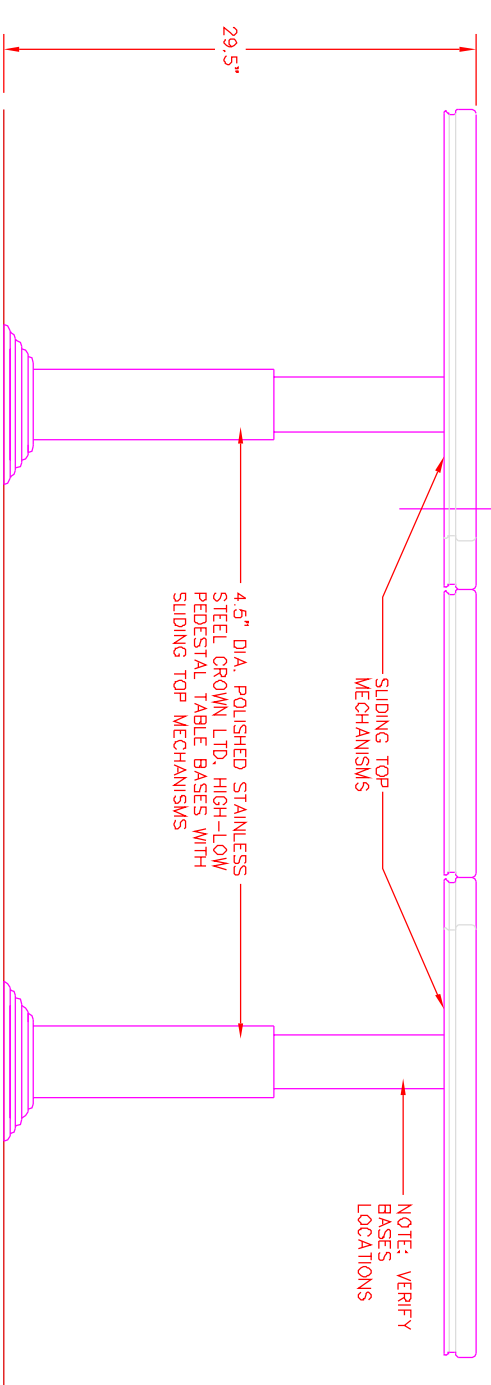

COCKPIT/AFT DECK TABLE/FRONT VIEW  
1'-0"=1'-0"

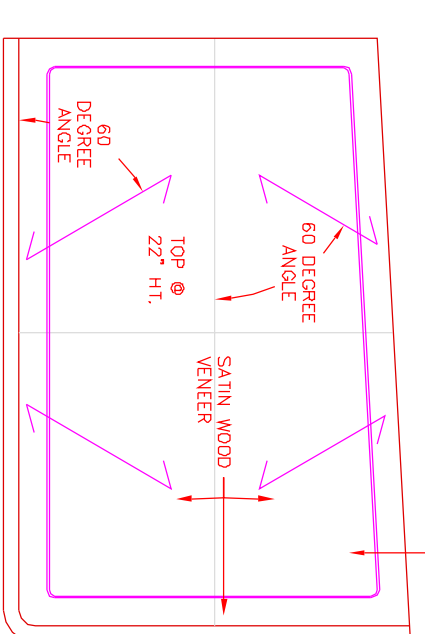

SALON AFT END TABLE/PLAN VIEW  
1'-0"=1'-0"

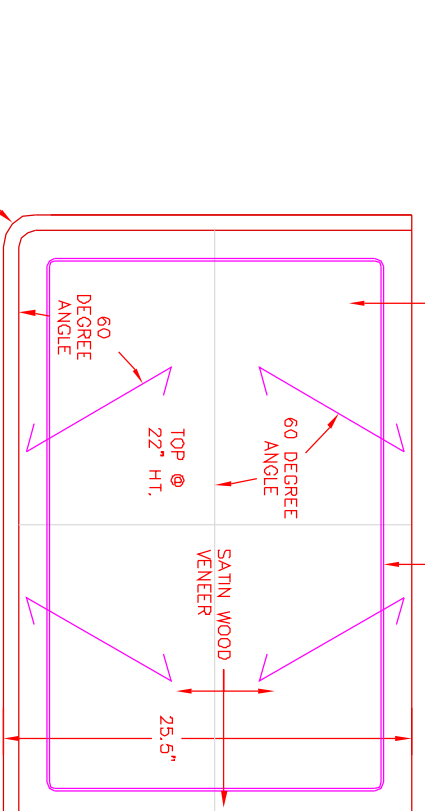

SALON FORWARD END TABLE/PLAN VIEW  
1'-0"=1'-0"

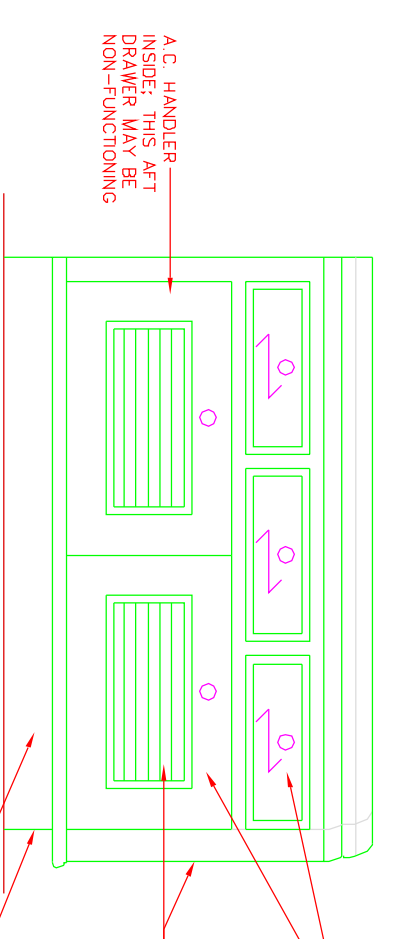

SALON AFT END TABLE/FRONT VIEW  
1'-0"=1'-0"

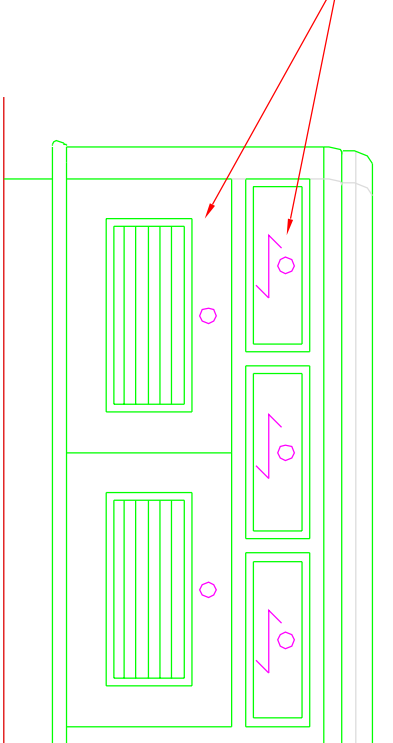

SALON FORWARD END TABLE/FRONT VIEW  
1'-0"=1'-0"

TABLE TOP AND SETTEE TOP SHALL BE 3/4" THICK AND 1/4" GAP BETWEEN TABLE AND SETTEE TOP.

TABLE TOP AND SETTEE TOP SHALL BE 3/4" THICK AND 1/4" GAP BETWEEN TABLE AND SETTEE TOP.

TABLE TOP AND SETTEE TOP SHALL BE 3/4" THICK AND 1/4" GAP BETWEEN TABLE AND SETTEE TOP.

TABLE TOP AND SETTEE TOP SHALL BE 3/4" THICK AND 1/4" GAP BETWEEN TABLE AND SETTEE TOP.

TABLE TOP AND SETTEE TOP SHALL BE 3/4" THICK AND 1/4" GAP BETWEEN TABLE AND SETTEE TOP.

TABLE TOP AND SETTEE TOP SHALL BE 3/4" THICK AND 1/4" GAP BETWEEN TABLE AND SETTEE TOP.

GENERAL NOTES:

1. ALL REMOVABLE COMPONENTS TO BE 3/4" X 3/4" X 3/4" UNLESS OTHERWISE NOTED BY ARCHITECT.
2. FINISH: GRIP-PAK POLYURETHANE COATING (100% SOLIDS) BY INTERIOR FINISHES.
3. BUILDER RESPONSIBLE FOR DETAILING AND CONSTRUCTION OF ALL COMPONENTS TO BE LOCATED AS SHOWN.
4. DIMENSIONS TO BE LOCATED AS SHOWN.
5. 100% SOLIDS POLYURETHANE COATING TO BE APPLIED TO ALL SURFACES TO BE PROTECTED BY FINISH.
6. FINISH TO BE APPLIED TO ALL SURFACES TO BE PROTECTED BY FINISH.
7. FINISH TO BE APPLIED TO ALL SURFACES TO BE PROTECTED BY FINISH.
8. FINISH TO BE APPLIED TO ALL SURFACES TO BE PROTECTED BY FINISH.
9. FINISH TO BE APPLIED TO ALL SURFACES TO BE PROTECTED BY FINISH.
10. BUILDER TO MAINTAIN CLEARANCE AS SHOWN.

NOTES:

THIS DRAWING IS INTENDED TO BE USED AS A GUIDE ONLY. ALL DIMENSIONS AND FINISHES SHALL BE BASED ON DIMENSIONS AND FINISHES SHOWN ON DRAWING. ALL DIMENSIONS AND FINISHES SHALL BE BASED ON DIMENSIONS AND FINISHES SHOWN ON DRAWING. ALL DIMENSIONS AND FINISHES SHALL BE BASED ON DIMENSIONS AND FINISHES SHOWN ON DRAWING.